

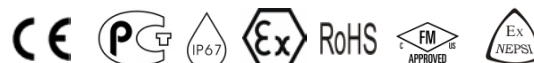

# Type H8C Load Cell



## Short description



- Nickel plated alloy steel IP67 shear beam load cell (100 kg, 250kg are bending beam load cells)
- Adhesive sealed
- Suitable platform weighing, bed weighing, etc.
- High accuracy
- High reliability
- Current calibrated (sc-option)

 test certificate no. TC8012 Revision 1  
C of C no R60/2000-NL1-12.12

 Certificate no. 12-028

## Available models

Capacity	Accuracy	Full article description
100kg	C3/C4/C5	H8C-C3/C4/C5-100kg-4B
250kg	C3/C4/C5	H8C-C3/C4/C5-250kg-4B
500kg	C3/C4/C5	H8C-C3/C4/C5-500kg-4B
1t	C3/C4/C5	H8C-C3/C4/C5-1.0t-4B
1.5t	C3/C4/C5	H8C-C3/C4/C5-1.5t-4B
2t	C3/C4/C5	H8C-C3/C4/C5-2.0t-4B
2.5t	C3/C4/C5	H8C-C3/C4/C5-2.5t-6B
3t	C3/C4/C5	H8C-C3/C4/C5-3.0t-6B
5t	C3/C4/C5	H8C-C3/C4/C5-5.0t-6B
10t	C3/C4/C5	H8C-C3/C4/C5-10t-6B

Specifications and dimensions are subject to change without notice and do not constitute any liability whatsoever.

## Detailed specifications H8C

Accuracy class		OIML R60 C3	OIML R60 C4	OIML R60 C5	
Output sensitivity ( = FS )	mV/V	3.0 ± 0.003			
Maximum capacity ( E <sub>max</sub> )	t	0.1, 0.25, 0.5, 1, 1.5, 2, 2.5, 3, 5, 10		0.1, 0.25, 0.5, 1, 1.5, 2, 2.5	3, 5, 10
Max.number of load cell intervals	n <sub>LC</sub>	3000	4000	5000	
Ratio of min. LC verification interval	Y = E <sub>max</sub> / v <sub>min</sub>	10000	15000	20000	18000
Combined Error	%FS	≤± 0.023	≤± 0.0175	≤± 0.014	
Minimum dead load	Of E <sub>max</sub>	0%			
Safe overload	of E <sub>max</sub>	150 %			
Ultimate overload	of E <sub>max</sub>	300 %			
Zero balance	of FS	< ± 1.0 %			
Excitation, recommended voltage	V	5 ~ 12			
Excitation maximum	V	18			
Input resistance	Ω	350 ± 3.5			
Output resistance	Ω	350 ± 3.5			
Insulation resistance	MΩ	≥5000 ( at 50VDC )			
Compensated temperature	°C	-10 ~ +40			
Operating temperature	°C	-35 ~ +65			
Storage temperature	°C	-40 ~ +80			
Element material		Nickel plated alloy steel			
Ingress Protection (acc. to EN 60529)		IP67			
Recommended torque on fixation	Nm	M12: 75	M18:500	M24:750	
ATEX classification (optional)		II1G Ex ia II1C T4	II1D Ex iaD 20 T73°C	II3G nL IIC T4	

## Wiring

### Wiring:

Shielded, 4 or 6 conductor cable

Cable diameter: Ø5mm.

Standard cable length for 100kg – 2t: 4m and 6m for the higher capacities.

Shield in not connected to the element.

### 4-wire diagram

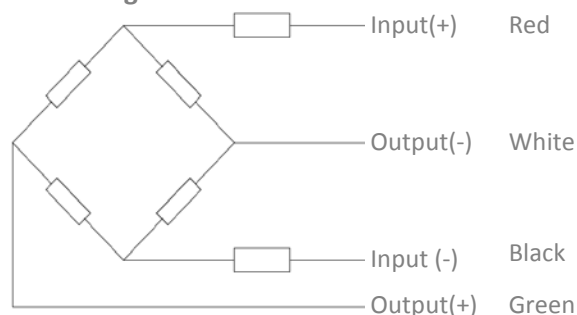

### 6-wire diagram

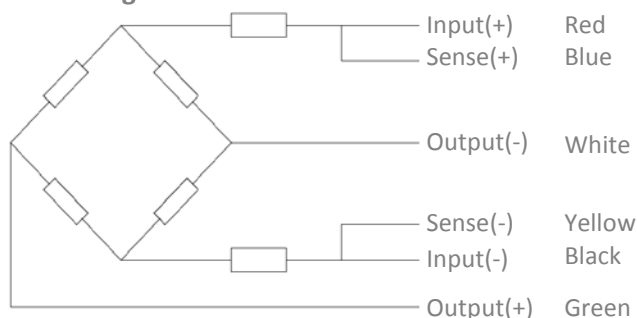

Specifications and dimensions are subject to change without notice and do not constitute any liability whatsoever.

# Type H8C Load Cell

## Ordering Info:

**H8C - C3 - 1.0t - 4 - - BX - SC - XX**

- Option XX. No mark is standard version, W4 is through loading hole, W6 is "T" end loading hole.
- Option SC (standard current).
- Cable option. No mark is 4 conductor cable and with a "6" a 6 conductor cable.
- Thread option. No mark is Metric Thread and "Y" is Imperial thread.
- Length of the cable in meters.
- Nominal capacity ( $E_{max}$ ) for Metric in t(on) and Imperial in lbs up to 500lbs and above in K(ilo)lbs.
- Maximum load cell divisions.
- Load Cell model.

## Dimensions in mm

### Standard version

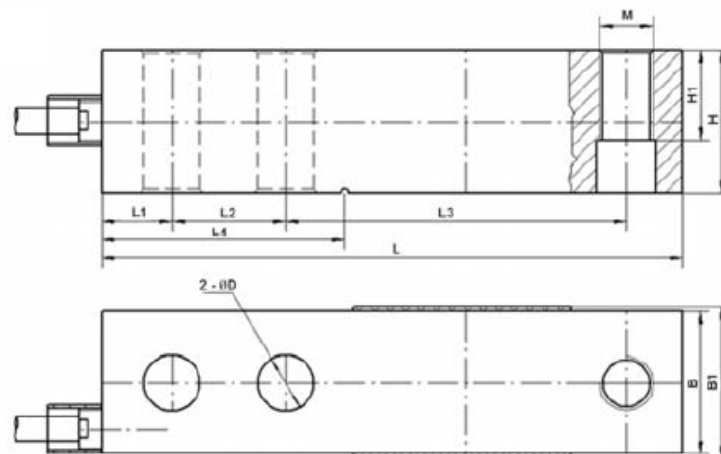

### Option W4 version (Through loading hole)

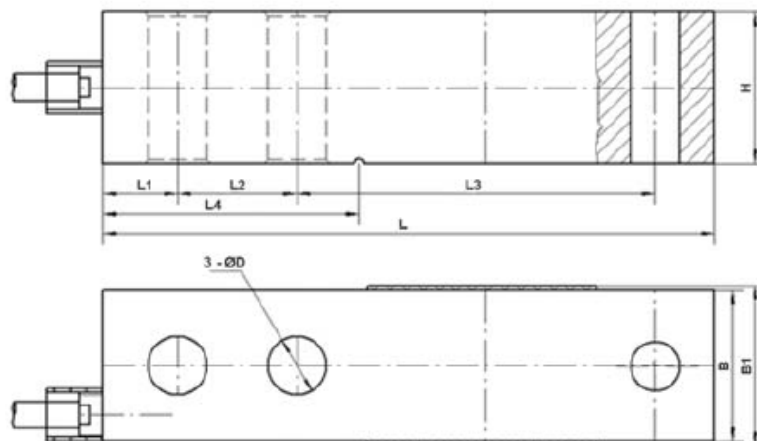

Specifications and dimensions are subject to change without notice and do not constitute any liability whatsoever.

# Type H8C Load Cell

Option W6 version ("T" end loading hole)

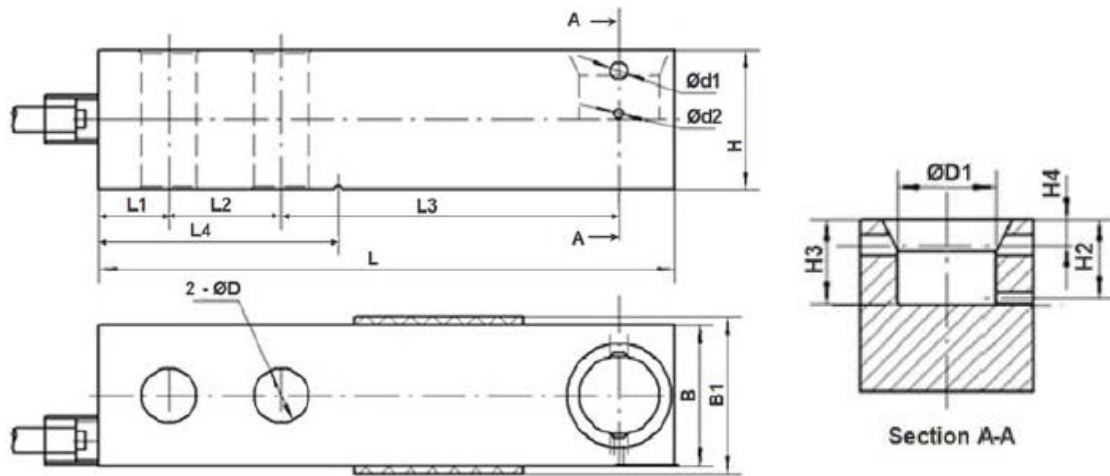

Dimension Capacity	L	L1	L2	L3	L4	B	B1	H	H1	H2	H3	H4	ØD	Ø D 1	Ø d 1	Ø d 2	M
0.1t-2t	130	15.8	25.4	76.2	54.2	31.8	34	31.8	15.8	14.5	15.8	4.8	13.5	18	4	2	M 12
2.5t-5t	171.5	19.1	38.1	95.3	77.2	38.1	40	38.1	18.8	17.5	18.8	4.8	19.8	25	4	2	M 18
10t	222.3	25.4	50.8	120.7	101.6	50.8	52.4	50.8	25.4	-	-	-	26	-	-	-	M 24

Specifications and dimensions are subject to change without notice and do not constitute any liability whatsoever.

# Type H8C Load Cell

## Available accessories

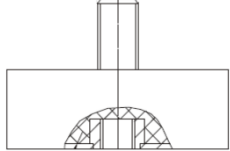
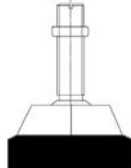
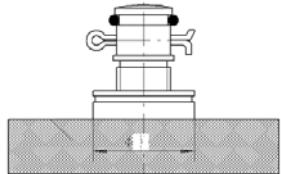
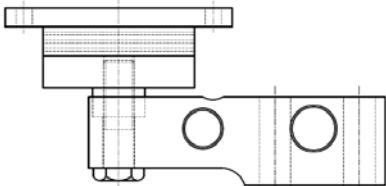
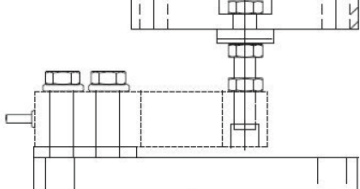
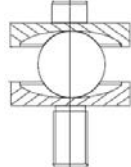
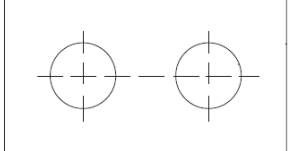
<p><b>HJ-8-201-0.1-10t foot</b></p> <ul style="list-style-type: none"> <li>• <math>\varnothing 60</math>-86 and height 92-112 mm</li> <li>• Nickel plated alloy steel</li> <li>• Adjustable height</li> </ul>	
<p><b>HJ-8-203-0.5-2t foot</b></p> <ul style="list-style-type: none"> <li>• <math>\varnothing 67</math> and height 46 mm</li> <li>• Nickel plated alloy steel</li> <li>• Easy installation</li> </ul>	
<p><b>HJ-8-213-0.5-2t foot</b></p> <ul style="list-style-type: none"> <li>• <math>\varnothing 60</math> and height 62 mm</li> <li>• Nickel plated alloy steel</li> <li>• Adjustable height</li> </ul>	
<p><b>HJ-8-236-0.25-5t foot</b></p> <ul style="list-style-type: none"> <li>• <math>\varnothing 80</math> and height 50 mm</li> <li>• Nickel plated alloy steel</li> <li>• Adjustable mount</li> <li>• Easy installation</li> </ul>	
<p><b>Elastomer-0.5-2t</b></p> <ul style="list-style-type: none"> <li>• Easy installation</li> <li>• Suitable for shock load</li> </ul>	
<p><b>HM-8-402-0.5-5t mount</b></p> <ul style="list-style-type: none"> <li>• Nickel plated alloy steel</li> <li>• Adjustable mounting height</li> <li>• Easy installation</li> </ul>	
<p><b>HY-8-102-0.5-5t</b></p> <ul style="list-style-type: none"> <li>• Nickel plated alloy steel</li> <li>• Easy installation</li> <li>• Good self-alignment ability</li> </ul>	
<p><b>HD-8-301-0.5-5t spacer plate</b></p> <ul style="list-style-type: none"> <li>• Nickel plated alloy Steel</li> </ul>	

Specifications and dimensions are subject to change without notice and do not constitute any liability whatsoever.